

TANGRAM PITAGORAS

Diagramas de la web: <http://www.nickrobinson.info/clients/owrigami/index.htm>

PYTHAGORAS

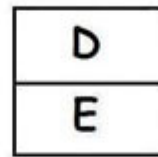
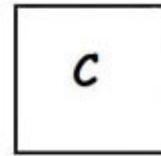
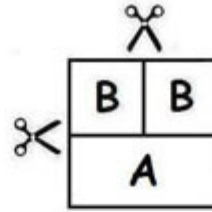
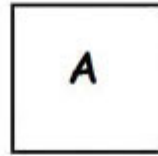
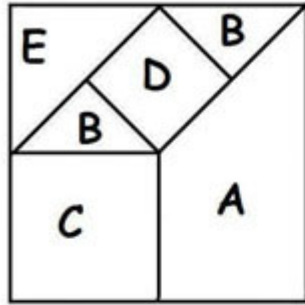

Recommended size - 15cm square.

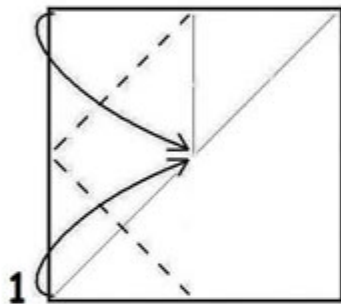

White side up.

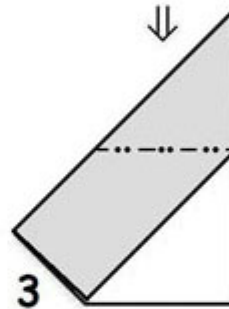
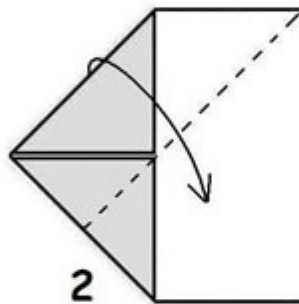

Reverse fold.

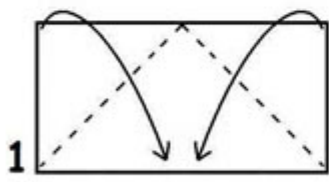
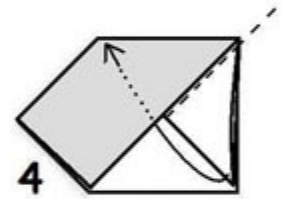

White side up.

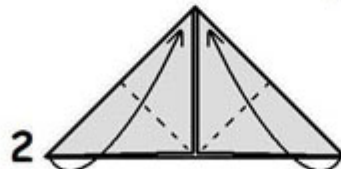

Rotate and insert to lock the flaps.

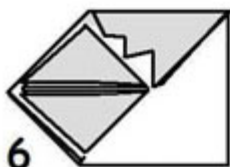
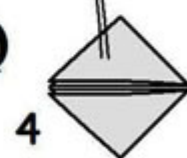
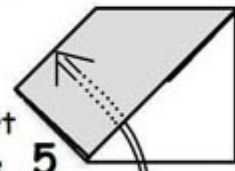
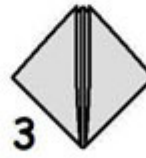

X-ray view.

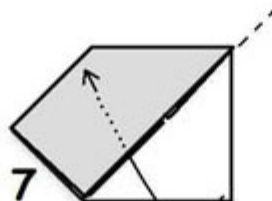

Insert to lock.

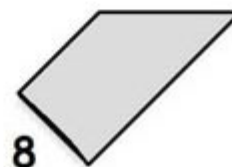

Complete.

B

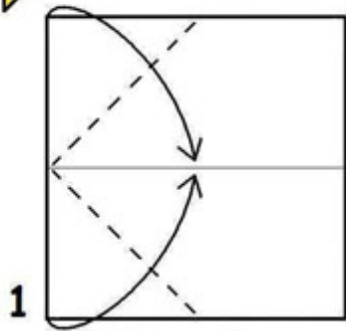

1

White side up.

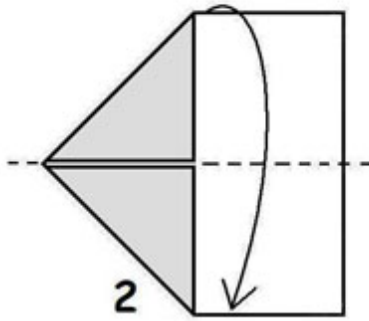

2

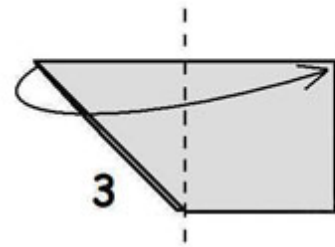

3

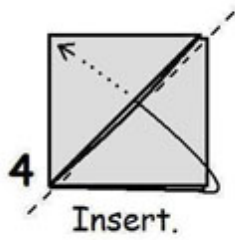

4

Insert.

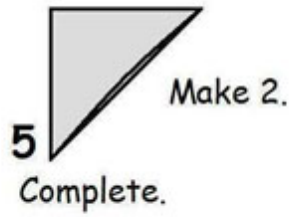

5

Complete.

C

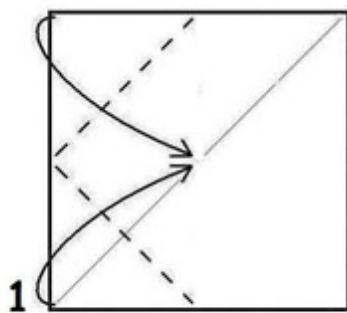

1

White side up.

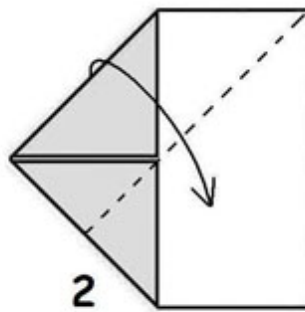

2

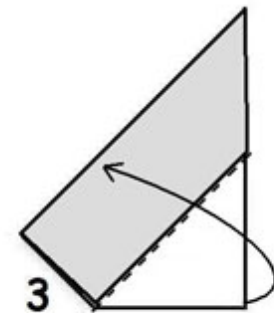

3

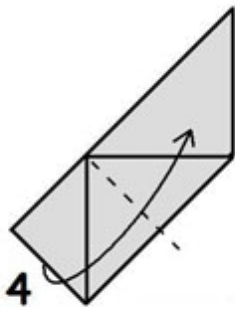

4

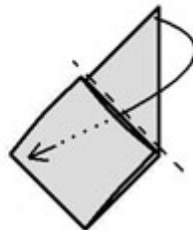

5

Insert.

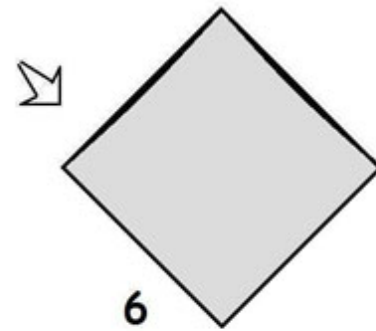

6

Complete.

D

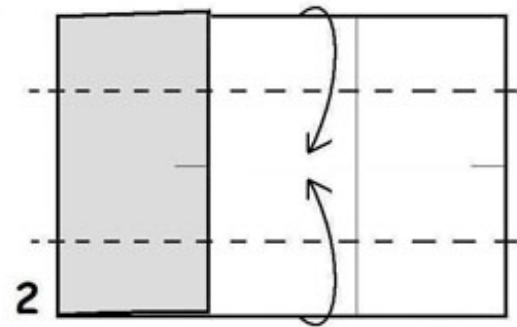
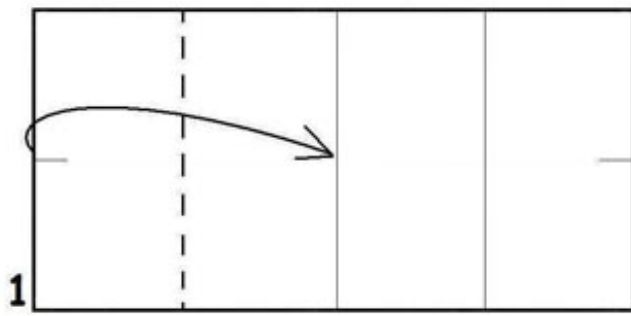

White side up. Pre-crease into 1/4s. Crease to mark the middle of the short edges and then fold the left edge to the middle crease line.

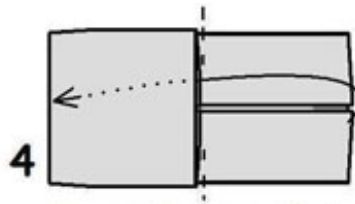
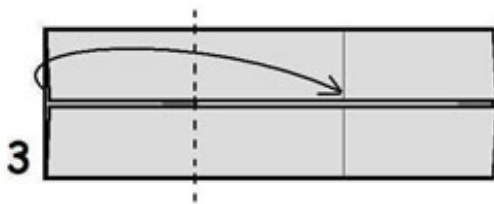

Insert into pocket.

Complete.

E

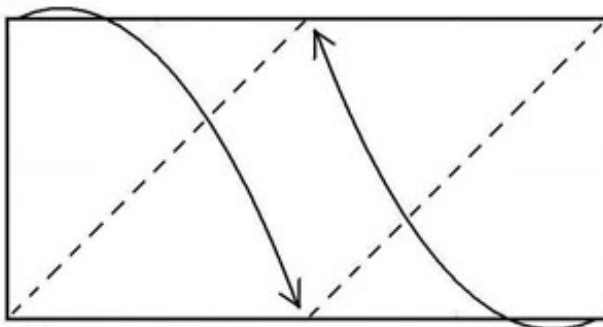

1 White side up.

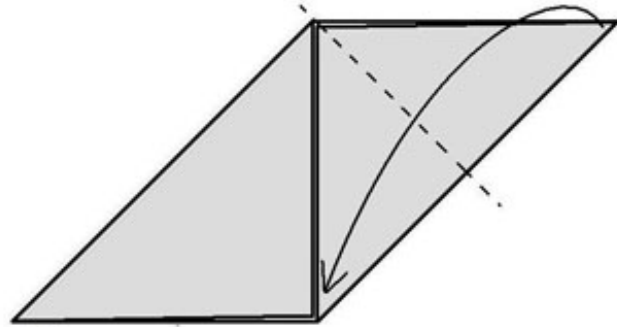

2

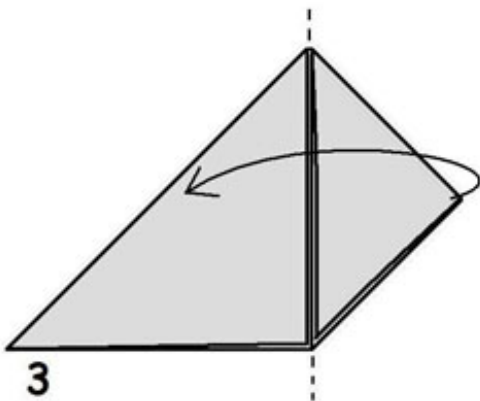

3

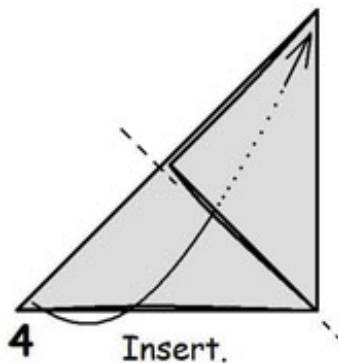

4

Insert.

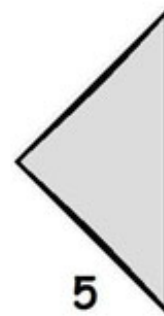

5

Complete.

