

T - PUZZLE

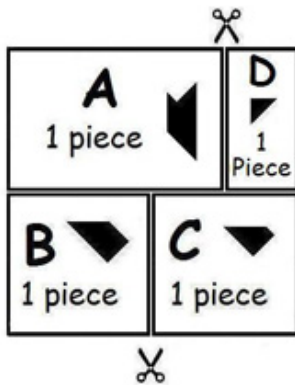

Paper size used to fold each shape.

SHAPE A

Colour side up.
Crease to locate 1/6 then fold to the 1/6 mark.

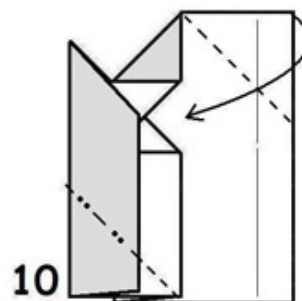
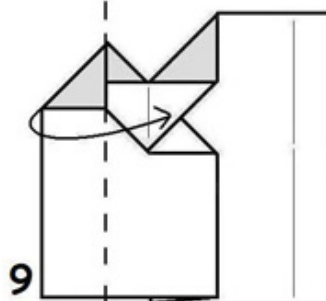
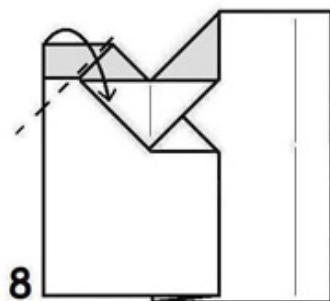
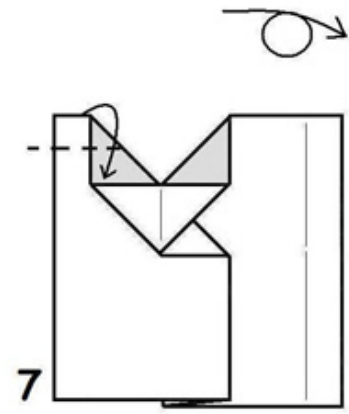
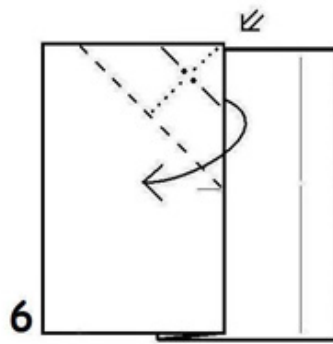
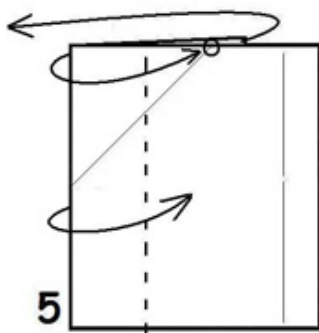
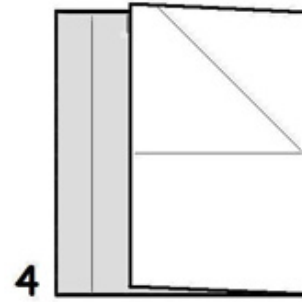
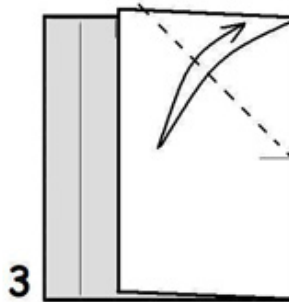
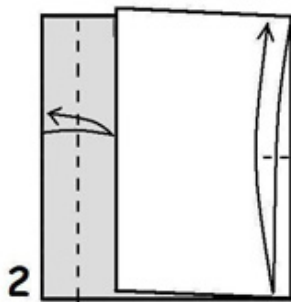
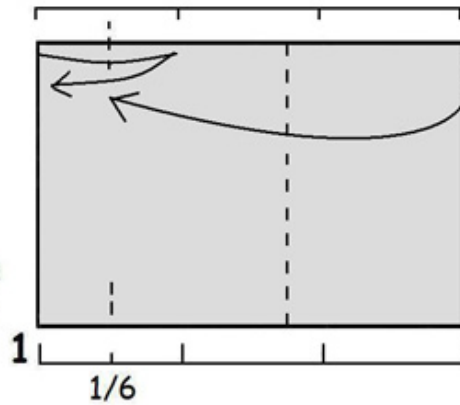

Reverse fold.

Diagramas de Francis Ow:

http://www.nickrobinson.info/clients/owrigami/show_diagram.php?diagram=tpuzzle

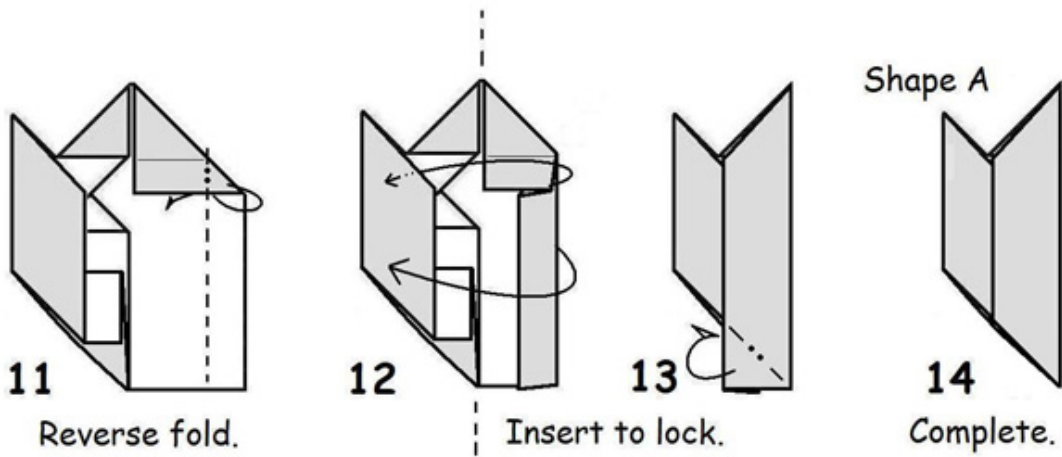

SHAPE B

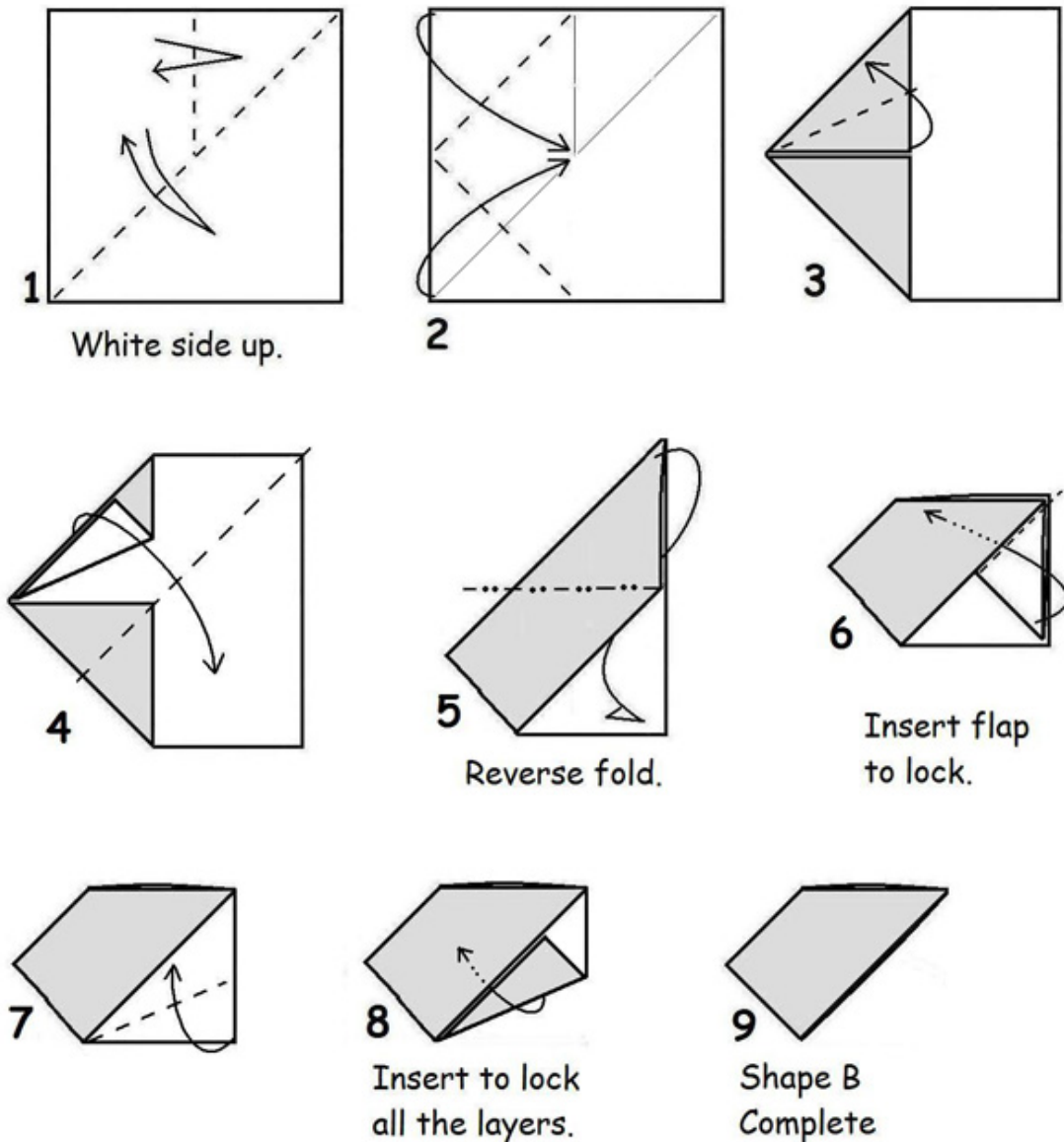

SHAPE C

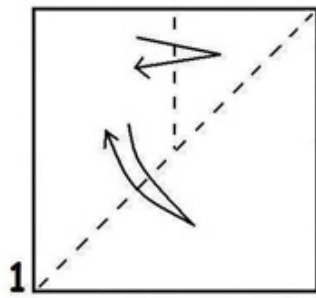

White side up.

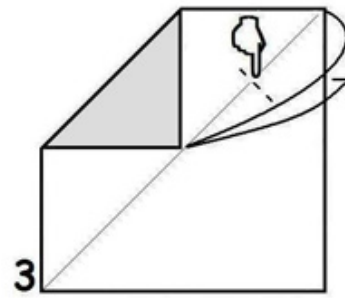
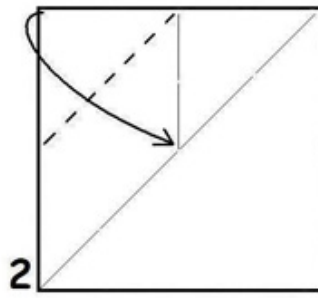

Crease to mark this point.

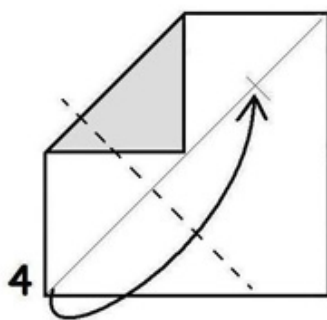

Fold corner to the crease mark.

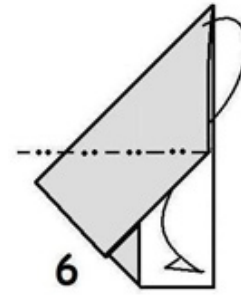
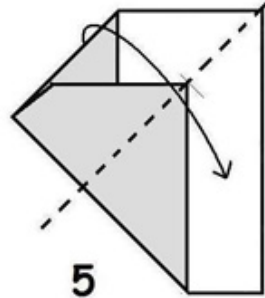

Reverse fold.

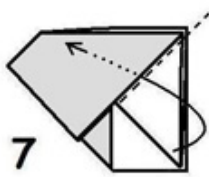

Insert.

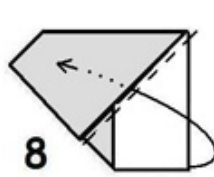

Insert.

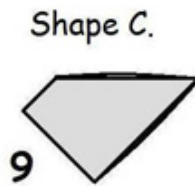

Complete.

Shape C.

Form a T with the 4 shapes.



SHAPE D

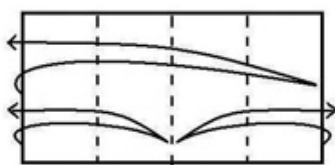

White side up.

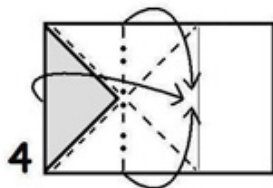
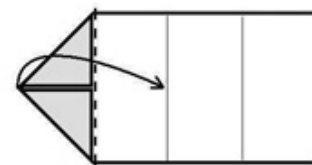
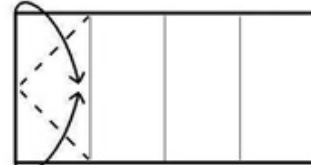

Waterbomb Base.

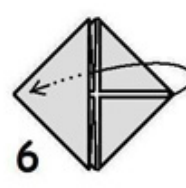
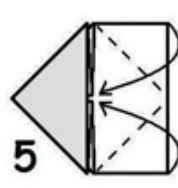



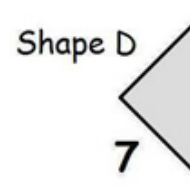



























Insert.



Shape D

Complete.

Figuras que se pueden construir

The 'T'	Fat T	italic T	Teezer	Propeller	Y Pentomino
					
Caldera	Arrow	Ramp	Happy Baby	Bowl	Stairs
					
7	y	Z	Lefty Z	Cane	Funiculaire
					
Halberd	Harpoon	Sword	Tomahawk	Villa	Factory
					
Boomerang	Hockey stick	Golf bag	Medium Golf bag	Tall Golf bag	Putter
					
Hand plane	Adjustable Spanner	Hammer	Anchor	Paperweight	Mounted L
